

**COLOR
TELEVISION**

**ELEGANCE 15 FLAT
MF 40-2501/5 TEXT**

**ENGLISH
ΕΛΛΗΝΙΚΑ
POLSKI
MAGYAR
HRVATSKI
SLOVENSKO**

GERUNDIG

CONTENTS

3

Set-up and safety

4

Connection/Preparation

4

Connecting the antenna and the mains cable

4

Inserting batteries in the remote control

5-6

Overview

5-6

The remote control

6

The front of the television set

7-9

Settings

7

Setting television channels automatically

8-9

Changing stored channels

9

Picture settings

10-11

Television operation

10

Basic functions

11

Changing the picture format

11

Zap function

12-13

Teletext mode

12

FLOF text and normal text mode

12-13

Additional functions

14-15

Convenience functions

14

Entering the switch-off time

14

Automatic volume

14

Changing the menu language

15

Parental lock

16

Using external devices

16

Decoder or satellite receiver

16

Camcorder

16

Connecting headphones

17-18

Special settings

17-18

Setting television channels

19-21

Information

19

Technical data

19

Service information for dealers

20

Troubleshooting

21

Additional Information for units sold in the UK

SET-UP AND SAFETY

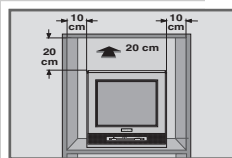

Please note the following information when setting up your television set.

This television set is designed to receive and display video and audio signals.

Any other use is expressly prohibited.

The ideal viewing distance is 5 times the screen diagonal.

External light falling on the screen impairs picture quality.

Ensure sufficient clearance between the TV and the wall cabinet.

The television set is designed for use in dry rooms. If you do use it in the open, please ensure that it is protected from moisture, such as rain or splashing water. Do not expose the television set to any moisture.

Do not place any vessels such as vases on the television, as they may spill liquid, thus presenting a safety risk.

Place the television set on a solid, level surface. Do not place any objects such as newspapers on the television set or cloth or similar items beneath it.

Do not place the television set close to heating units or in direct sunlight, as this will impair cooling.

Heat build-up can be dangerous and shortens the operating life of the television set. For reasons of safety, have a specialist remove any dirt deposits in the set from time to time.

Keep the television set away from magnetic fields (loudspeaker boxes, for example).

Do not open the television set under any circumstances. Warranty claims are excluded for damage resulting from improper handling.

Ensure that the mains cable is not damaged.

Thunderstorms are a danger to all electrical devices. Even if the television set is switched off, it can be damaged by a lightning strike to the mains or the antenna cable. Always disconnect the mains and antenna plugs during a storm.

Clean the screen with a soft, damp cloth. Only use plain water.

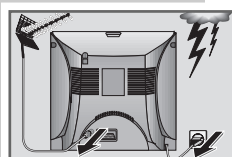
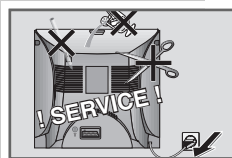
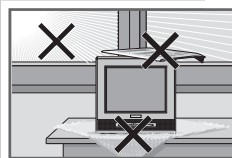
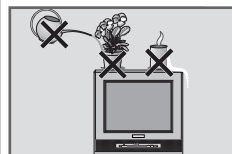

CONNECTION/PREPARATION

Connecting the antenna and the mains cable

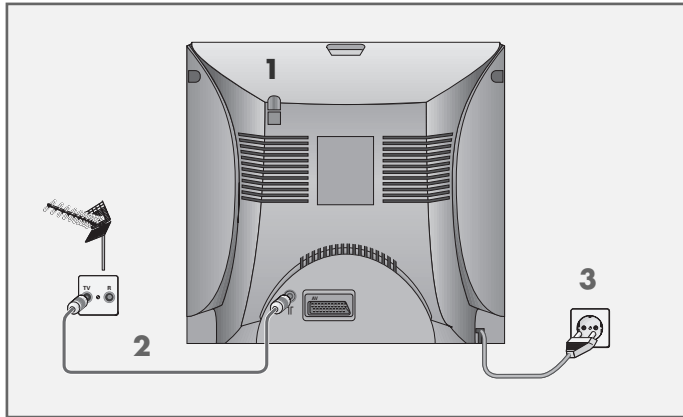

- 1 Insert the telescopic antenna in the recess in the rear panel.
- 2 Plug the antenna cable of the rooftop antenna into the »⏏« antenna socket on the television.
- 3 Plug the mains cable into the wall socket.

Inserting batteries in the remote control

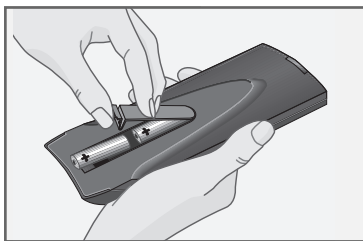

- 1 Open the battery compartment by removing the lid.
- 2 Insert the batteries (Mignon type, for example UM-3 or AA, 2x1,5V).
Observe the polarity (marked on the base of the battery compartment).
- 3 Close the battery compartment.

Note:

If the television no longer reacts properly to remote control commands, the batteries may be flat. Be sure to remove used batteries.

The manufacturer accepts no liability for damage resulting from used batteries.





Environmental note

Batteries, including those which contain no heavy metal, may not be disposed of with household waste. Please dispose of used batteries in an environmentally sound manner. Find out about the legal regulations which apply in your area.

OVERVIEW

The remote control



-  Switches off the television set (stand-by).
- PIP** Key has no function.
-  Switches between picture formats.
- /--** Switches between single and double-digit preset channels; switches to double character size in teletext mode.
- 1...0** Switches the television on from standby mode; selects channels directly.
-  Sound on/off (mute).
- i** Opens and closes the info menu; closes all menus.
- Z** Zap function.
- P+, P-** Switches the television on from standby; selects stations step by step; moves the cursor in the menus up and down.
-  Adjusts the volume; moves the cursor left/right.
- OK** Calls up the preset channels; activates various functions.
- TXT** Switches between teletext and TV modes.
- AV** Selects the AV channels and the most recently viewed television channel.
- SCAN** Reveal answer in teletext mode.
- PAP** Page stop in teletext mode.
- SIZE** Selects the sub-pages in teletext mode.
- POS** Updates a page in teletext mode.

OVERVIEW



Selects a page in teletext mode.



Time on.
selects a page in teletext mode.



Selects a page in teletext mode.



Selects a page in teletext mode.

VCR, SAT DVD

Switches to operating a GRUNDIG video recorder, a GRUNDIG satellite receiver or a GRUNDIG DVD player.

Keep the relevant buttons (»VCR«, »SAT«, »DVD«) pressed down. Then press the button you require.

Note:

The functions available to you depend on the model of the device you are using.

Just try it out.

The front of the television set

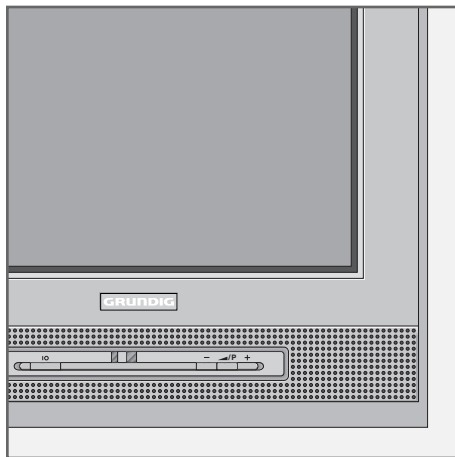

Switches the television to standby mode and off again.



Switches the television on from standby mode.
Preset button for volume and channel selection.



Channel select down.
Lower volume.



Channel select up.
Raise volume.

Sockets on the right



Headphone jack (3.5 mm ø jack plug).



Video signal input for camcorder.



Audio signal input (mono) for camcorder.

SETTINGS

Setting television channels automatically

The television set is equipped with an automatic channel search system.

You start the search and can then sort the television channels into your order of preference.

100 preset positions are provided, to which you can assign television channels from the antenna or from the cable connection.

You can also delete television channels from the channel list which were found more than once or which have poor reception.

- 1 Switch on the television with »**I**« on the television set, then press »**P+**« on the remote control.
 - The »Language« menu appears when the television is first switched on.

Hint:

If the »Language« menu does not appear on the screen, then set it in accordance with the chapter on resetting all television channels on page 18.

- 2 Select language with »**P+**«, »**P-**«, »**◀**« or »**▶**« and press »**OK**« to confirm.
 - The »Country Selection« menu appears.

- 3 Press »**P+**«, »**P-**«, »**◀**« or »**▶**« to select the country and »**OK**« to confirm.

Note:

If your country is not displayed, select ». «.

- 4 Press »**OK**« to start the search.
 - The »Setup« menu appears and the search begins. The automatic search may last several minutes depending on the number of television channels received.

Note:

After the search you can press »**TEXT**« to finish the setting. The TV channel is stored in a useful order

or with »**i**« you can go to the »Program Table« menu, where the channels can be arranged as you want.

Information on editing the »Program Table« can be found on the next page.

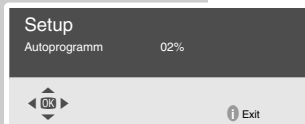
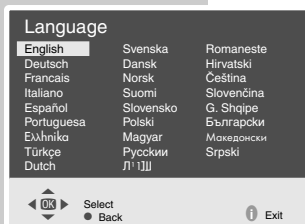

SETTINGS

Changing stored channels

You can delete channels that have been stored more than once during the automatic search. You can also store channels in a different preset position, change or enter the name of a channel as well as skip channels.

Selecting the station list

- 1 Press **»i«** to open the **»Main Menu«**.
– The **»Main Menu«** appears.
- 2 Select **»Program Table«** with **»P+«** or **»P-«** and confirm with **»OK«**.
– The **»Program Table«** menu appears.

Note:

Further operation is explained in the following sections.

Deleting channels

- 1 In the **»Program Table«** menu, select the station to be deleted by pressing **»P+«, »P-«, »◀«** or **»▶«**.
- 2 Press **»□□«** (yellow) to delete the channel.

Note:

To delete other stations, repeat steps **1** and **2**.

Sorting television channels

- 1 In the **»Program Table«** menu, select the channel to be moved with **»P+«, »P-«, »◀«** or **»▶«**.
- 2 Highlight the channel with **»⌚«** (green).
- 3 Select a new channel position by pressing **»P+«, »P-«, »◀«** or **»▶«** and then press **»⌚«** to confirm.
– All of the channels that follow move up one position.

Note:

To sort the other television channels repeat steps **1** to **3**.

Entering the channel names (maximum of 5 characters)

- 1 In the **»Program Table«** menu, select the desired channel with **»P+«, »P-«, »◀«** or **»▶«**.
- 2 Highlight the channel with **»?«** (blue).
- 3 Select letters or numbers with **»P+«** or **»P-«, »◀«** or **»▶«** and repeat.
- 4 Store the channel name with **»?«** (blue).

Note:

To enter additional channel names, repeat steps **1** to **4**.

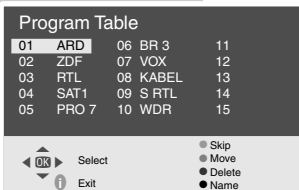
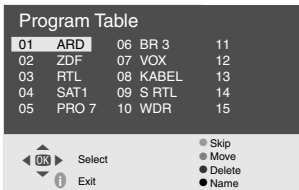
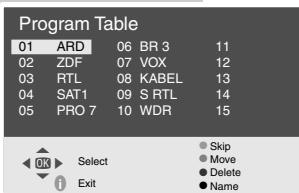
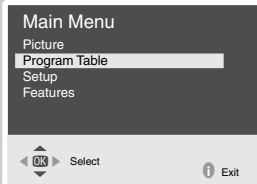

SETTINGS

Skipping television channels

You can mark television channels which should be skipped during selection with »P+« or »P-«. A selection with the number keys is also possible.

Program Table			
01	ARD	06 BR 3	11
02	ZDF	07 VOX	12
03	RTL	08 KABEL	13
04	SAT1	09 S RTL	14
05	PRO 7	10 WDR	15

Legend:

- Skip
- Move
- Delete
- Name

Navigation: **OK** Select, **i** Exit

- 1 In the »Program Table« menu, select the desired channel with »P+«, »P-«, »◀« or »▶«.
- 2 Highlight the channel with »👁« (red).
 - The television channel is now displayed against a red background.
 - You can deselect the selected channel by pressing the red button again.

Concluding the settings

- 1 Press »i« to finish the settings.

Picture settings

- 1 Press »i« to open the »Main Menu«.
 - The »Main Menu« appears.
- 2 Select »Picture« with »P+« or »P-« and confirm with »OK«.
 - The »Picture« menu appears.
- 3 Select »Brightness«, »Contrast«, »Colour« or »Sharpness« with »P+« or »P-« and adjust them with »◀« or »▶«.
- 4 Select »Store« with »P+« or »P-« and confirm the setting with »OK«.
 - The »Stored« message appears.
- 5 Press »i« to finish the settings.



TELEVISION OPERATION

Basic functions



Switching on and off

- 1 Switch on the television by pressing the »**⏻**« button on the television set.
– The device switches to standby mode.
Switch the television on with »**1...0**« or »**P+**« or »**P-**«.
- 2 Press the »**⏻**« button to switch the television to standby mode.
Press »**1...0**« or »**P+**« or »**P-**« to switch on the device from standby mode.
- 3 Completely switch the television off by pressing »**⏻**« on the television set.
– This saves electricity.

Selecting channels

- 1 Use »**1...0**« to select channels directly.
Preselect two digit channel positions with »**-/--**«.
- 2 Press »**P+**« or »**P-**« to move up and down channels.

Selecting AV channel positions

- 1 Use »**AV**« to select AV channels directly.

Adjusting the volume

- 1 Adjust the volume with »**◀**« or »**▶**«.

Muting

- 1 Use »**🔇**« to switch the sound off (mute) and to switch it on again.

Displaying time

- 1 You can display the time by pressing the »**⌚**« button (only for channels with teletext).

TELEVISION OPERATION

Changing the picture format

The television automatically switches to the 16:9 format, if this format is recognised via the Euro-AV socket.

- 1 Select the picture format with **»[P]«**. The selected picture format, for example **»16:9«**, appears on the screen.
 - You can choose between the following picture formats:

»Auto« format

The picture format is automatically switched to **»16:9«** for 16:9 programmes.

The picture format is automatically switched to **»4:3«** for 4:3 programmes.

»4:3« format

For 4:3 programmes, select picture format **»4:3«**.

»16:9« format

For 16:9 programmes, select picture format **»16:9«**.

Zap function

This function allows you to save the television channel which you are currently watching and switch to other channels (zapping).

- 1 Select the channel you want to save in the zap memory with **»1...0«** or **»P+«** **»P-«**, (e.g. channel 1, BBC 1) and save by pressing **»Z«**.
 - The display **»z -> P1 BBC1«** appears in the screen.
- 2 Change channels with **»1...0«** or **»P+«** **»P-«**.
- 3 You can now use **»Z«** to switch between the saved channel (in the example, BBC1) and the channel you were watching before.
- 4 Press **»i«** to quit the zap function.
 - The display disappears.

TELETEXT MODE

FLOF text and normal text mode

Switching on teletext and selecting pages

- 1 Press »TXT« to switch on teletext.
- 2 Use »0...9« to enter the page number directly or »P+« and »P-« to switch up and down pages (to return to page 100, press »I«).

Note:

At the bottom of the screen, you will see an information line consisting of a red, green, yellow and blue text field. Your remote control has buttons with the corresponding colours.

- 3 Press »👁« (red), »🟢« (green), »🟡« (yellow) or »🟠« (blue) to select a teletext page. This depends on the options in the information line.
- 4 Press »TXT« to switch off teletext.

Additional functions

Waiting

While a page is being searched for, you can switch to the television channel.

- 1 Enter the number of the teletext page with »1...0« and then press »POS«.
– As soon as the page is found, the teletext page number appears in the top left hand corner of the screen.
- 2 Switch to the teletext page by pressing »POS«.

Increasing character size

If you have difficulty reading the text on the screen, you can double the character size.

- 1 To enlarge the character size of a teletext page, press »-/-« repeatedly.

Page stop

A multiple page may contain several sub-pages, which are automatically scrolled by the transmitting station.

- 1 Stop the sub-pages with »PAP«.
- 2 Press »PAP« to quit the function.



TELETEXT MODE

Calling up a sub-page directly

If the selected teletext page contains additional pages, the number of the current sub-page as well as the total number of pages is displayed.

- 1 Call up the sub-pages with »**SIZE**«.
- 2 Enter the four-digit number for the sub-page with »**1...0**«.
– The selected sub-page is displayed after a short delay.

Reveal answer

Certain teletext pages contain "hidden answers" or information which can be called up.

- 1 Display information with »**SCAN**«.
- 2 Conceal information with »**SCAN**«.

CONVENIENCE FUNCTIONS

Entering the switch-off time

You can enter a switch-off time. After this time has elapsed, the television switches to standby mode.

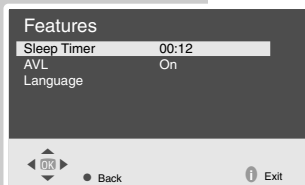

- 1 Press »i« to open the »Main Menu«.
– The »Main Menu« appears.
- 2 Select »Features« with »P+« or »P-« and confirm with »OK«.
- 3 Select »Sleep Timer« with »P+« or »P-«.
- 4 Enter the required time (in 15 minute intervals from 15 to 120 minutes) by pressing »◀« or »▶«.
- 5 Press »i« to finish the setting.

Note:

To delete the switch-off time, select »Sleep Timer« again and press »◀« or »▶« to select »Off«.

Automatic volume

Television stations broadcast at different volumes. The automatic volume limiting (AVL) function means the volume is kept the same when you switch between channels.

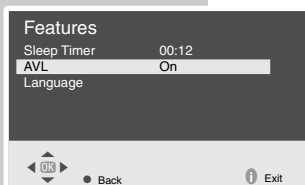

- 1 Press »i« to open the »Main Menu«.
– The »Main Menu« appears.
- 2 Select »Features« with »P+« or »P-« and confirm with »OK«.
- 3 Select »AVL« with »P+« or »P-« and then select »On« with »◀« or »▶«.
- 4 Press »i« to finish the setting.

Changing the menu language

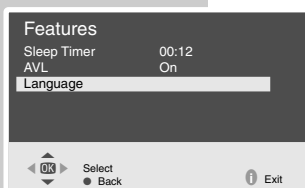

- 1 Press »i« to open the info menu.
– The info menu appears.
- 2 Select »Features« with »P+« or »P-« and confirm with »OK«.
- 3 Select »Language« with »P+« or »P-« and confirm with »OK«.
– The »Language« menu appears.
- 4 Select the language with »P+«, »P-« and press »OK« to confirm.
- 5 Press »i« to finish the setting.

CONVENIENCE FUNCTIONS

Parental lock

You can block any station. The screen goes black.

- 1 Press »i« to open the info menu.
– The info menu appears.
- 2 Select »Search« by pressing »P+« or »P-«.
- 3 Select »Child Lock« with »P+« or »P-«.
- 4 Press »◀« or »▶« to activate or deactivate the parental lock (On) or (Off).
- 5 Press »i« to finish the setting.

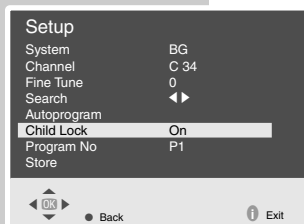

USING EXTERNAL DEVICES

Decoder or satellite receiver

Connecting a decoder or satellite receiver

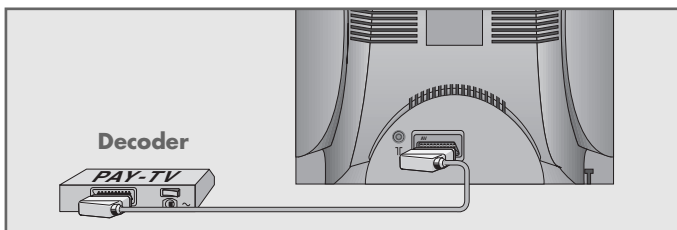

- 1 Connect the »AV1« socket on the television set and the appropriate socket on the decoder using a EURO-AV cable.

Notes:

A satellite receiver can also be connected to this socket.

If you want to use both a satellite receiver and a decoder, the decoder must be connected to the satellite receiver.

Using a decoder

- 1 Switch on the television and the decoder.
- 2 Select the »AV1« channel by pressing »AV«.

Using an S-Video device

If you have a device with an S-Video output (such as a DVD player), you can connect it using a EURO/AV (Scart) cable to the »AV1« socket.

Press »AV« to select the »AV1-S« channel.

Camcorder

Connecting the camcorder

- 1 Connect the yellow socket (VIDEO – picture signal) on the television and the corresponding socket on the camcorder (VHS, Video 8) with a cinch cable.
- 2 Connect the white socket (AUDIO – mono signal) on the television and the corresponding socket of the camcorder using a cinch cable.

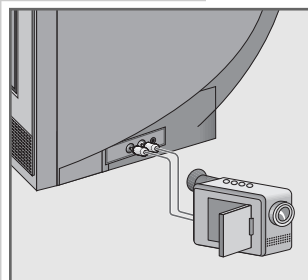

Operating with a camcorder

- 1 Switch on the camcorder, insert a cassette and start playback.
- 2 Select the »AV2« channel with »AV«.

Connecting headphones

- 1 Insert the headphone jack (3.5 mm ø jack plug) in the headphone socket on the television.

SPECIAL SETTINGS

Setting television channels

This setting is only necessary if a new channel comes on air and you do not want to change the order of your channels. The television channel can be set directly or using the search.

Setting channels using the search

- 1 Press »i« to open the »Main Menu«.
- 2 Select »Setup« with »P+« or »P-« and confirm with »OK«.
– The »Setup« menu appears.
- 3 Select »Program No« with »P+« or »P-« and set the preset channel with »◀« or »▶«.
- 4 Select »Search« with »P+« or »P-« and start the search with »◀« or »▶«.
– If a strong station signal is received, the search is interrupted and the picture appears. Repeat the search until the channel you want appears on the screen.

Note:

The current system is displayed in the »System« line. If the colour or sound are incorrect, select »System« with »P+« or »P-«. Make the necessary adjustments with »◀« or »▶«.

- 5 Select »Store« with »P+« or »P-« and confirm with »OK«.
– The »Stored« message appears.

Note:

To set other television stations, repeat steps 3 to 5.

- 6 Press »i« to finish the setting.

Fine tuning television channels

The television automatically tunes itself to the best possible reception. You may need to carry out manual fine tuning in areas where there is poor reception.

- 1 Press »i« to open the »Main Menu«.
- 2 Select »Setup« with »P+« or »P-« and confirm with »OK«.
– The »Setup« menu appears.
- 3 Select »Fine Tune« with »P+« or »P-« and set it with »◀« or »▶«.
- 4 Select »Store« with »P+« or »P-« and confirm with »OK«.
– The »Stored« message appears.
- 5 Press »i« to finish the setting.

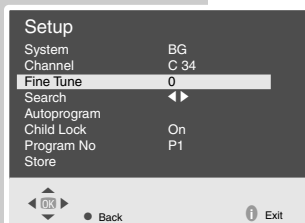
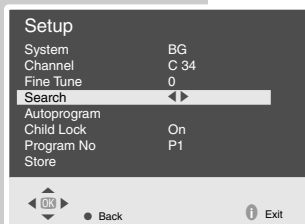

SPECIAL SETTINGS

Setting the television channels by entering the channel numbers

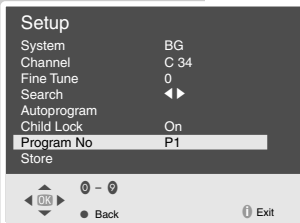
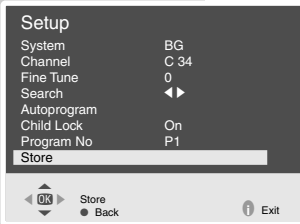
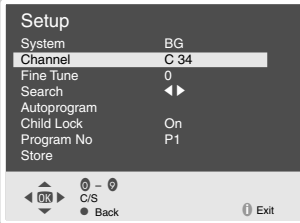
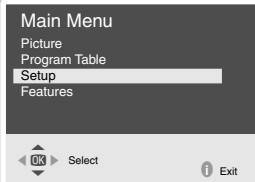

- 1 Press »i« to call up the »Main Menu«.
- 2 Select »Setup« with »P+« or »P-« and confirm with »OK«. – The »Setup« menu appears.
- 3 Select »Program No« with »P+« or »P-« and set the channel with »◀« or »▶«.
- 4 Select »Channel« with »P+« or »P-« and confirm with »OK«.
- 5 Press »OK« to choose between »S« (special channel) and »C« (channel).
- 6 Press »◀« or »▶« to switch up and down channels or use »1...0« to enter the channel number directly.

Note:

The current system is displayed in the »System« line.

If the colour or sound are incorrect, select »System« with »P+« or »P-«. Make the necessary adjustments with »◀« or »▶«.

- 7 Select »Store« with »P+« or »P-« and confirm with »OK«.
- 8 Press »i« to finish the setting.

Note:

To set other television stations, repeat steps 3 to 7.

Re-tuning all television channels

You can re-tune all the television stations, for example if you move to another town.

- 1 Press »i« to open the »Main Menu«.
- 2 Select »Setup« with »P+« or »P-« and confirm with »OK«. – The »Setup« menu appears.
- 3 Select »Program No« with »P+« or »P-« and using »◀« or »▶« enter the channel numbers from the point they should be saved.
- 4 Select »Autoprogram« with »P+« or »P-« and confirm with »OK«. – The »Autoprogram« menu appears.
- 5 Select the country using »P+«, »P-«, »◀« or »▶« and confirm with »OK«.
- 6 Press »OK« to start the search. – The automatic search may last a few minutes, depending on the number of television channels received.

Note:

You can interrupt the search by pressing »i«.

INFORMATION

Technical data

Mains voltage:	230 V, 50/60 Hz
Power consumption:	In standby mode 4 W Switched on 45 W
Sound output:	5 Watts music
Reception ranges:	C01 ... C99, special channels S01 ... S41, frequency band 1 ... 4
Channel positions:	100 und 2 AV

Service information for dealers:

The product complies with the following EU directives:
73/23/EEC directive for electrical equipment to be used within defined voltage ranges. 89/336/EEC directive on electromagnetic compatibility.

The television set complies with the following standards: EN 60065, EN 55013, EN 55020



INFORMATION

Troubleshooting

If the remedies given below do not work, please consult an authorised GRUNDIG dealer. Please bear in mind that malfunctions can also be caused by external devices such as video recorders or satellite receivers.

Fault	Possible cause	Remedy
Screen lit (snow), but no station	Antenna cable	Is the antenna cable connected?
	No television station programmed	Start the station search
Poor picture contrast	Picture settings incorrectly set	Adjust the brightness, contrast or colour setting
	Problem at station	Test with another channel
Interference to picture and/or sound	Interference from other devices	Change the position of the device
Ghosts, reflection	Channel setting	Automatic or manual channel setting/fine tuning
	Antenna	Have antenna cable or system checked
No colour	Colour intensity at minimum	Turn up the colour
	TV standard setting (if setting option is available)	Select the correct colour standard
	Problem at station	Test with another channel
Inappropriate colour, colour spots	Strong magnetic field due, for example, to loudspeakers	Move the loudspeakers away from the television. If colour spots remain, switch off the television set at the mains and switch on again after 10 minutes
Picture but no sound	Volume set to minimum	Turn up or switch on the volume
	Problem at station	Test with another channel
Teletext missing or faulty	Television station (has no teletext) or antenna system	Test another channel for fine tuning and ghosts
	Station signal too weak	Check the antenna system
Remote control does not work	No optical connection	Point the remote control at the television set
	Remote control batteries	Check the batteries, change if necessary
	Operating condition undefined	Switch off the television with the main power button for approximately 2 minutes
The picture is unrecognisable after switching on the television	Parental lock has been activated	Switch off the parental lock

INFORMATION

Additional Information for units sold in the UK.

Units sold in the UK are suitable for operation from a 240V ac, 50Hz mains supply.

The range of multi-system receivers is built to work in most European countries. However, the mains plug and socket system for the UK differs from many European countries.

This appliance has been supplied with a fitted, non-removable, approved converter plug for use in the UK. This converter plug is fitted with a 5A rated fuse.

In case this appliance is supplied with a moulded 2-pin Euro plug only, which is unsuitable for UK operation, this must be cut off and immediately disposed of. An approved 13A, 3-pin UK plug should then be fitted by a qualified electrician.

Note:

The severed Euro plug must be destroyed to avoid a possible shock hazard should it be inserted into a socket elsewhere.

If a non-rewireable 3-pin plug or a rewireable 13A (BS1363) 3-pin plug is used, it must be fitted with a 5A ASTA or BSI approved BS1362 fuse. If any other type of plug is used it must be protected by a 5A fuse either in the plug, or at the distribution board. If this type of plug becomes defective, ensure that the fuse is removed before disposal, to eliminate potential shock hazard.

If it is necessary to change the fuse in the non-rewireable plug, the correct type and rating (5A ASTA or BSI approved BS1362) must be used and the fuse cover must be refitted. If the fuse cover is lost or damaged, the lead and plug must not be used until a replacement is obtained. Replacement fuse covers should be obtained from your dealer.

Important:

The wires in the mains lead are colour coded in accordance with the following code:

BLUE – NEUTRAL

BROWN – LIVE

As the colours of the wires in the mains lead of your appliance may not correspond with the coloured marking identifying terminals in your plug, proceed as follows:

Connect the BLUE coloured wire to plug terminal marked with the letter "N" or coloured black.

Connect the BROWN coloured wire to the plug terminal marked with the letter "L" or coloured red.

In no circumstance must any of the wires be connected to the terminal marked with the letter "E", earth symbol "⏏", coloured green, or green & yellow.